

2T0122DD | OZ Lighting module - Wall Washer

Wall Washer magnetic LED light modules, powered at low voltage

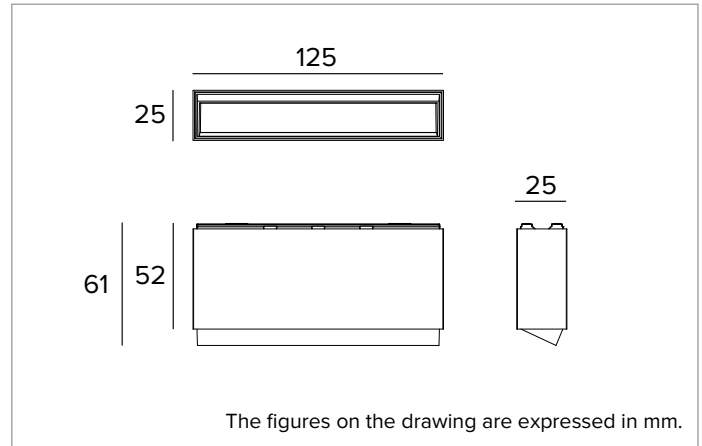

		4000K	H(m)	D1(m)	D2(m)	E _{max} (lx)	
		Ra90	35°	77°			
Fixture Power	8W	1	0.67	1.65	397		
Source Flux	704lm	2	1.34	3.30	99		
Fixture Flux	453lm	3	2.00	4.95	44		
Efficacy	55lm/W	4	2.67	6.60	25		
TS1842	I _{max} =610cd/klm	I _{max}	430cd	5	3.34	8.24	16



SOURCE

Hugh efficiency Ra90 LED Emitter.

Energy efficiency class: F

Nominal power: 7,3W

Nominal flux: 704lm

Colour rendering index: 90

Rf: 90.9

Rg: 101.1

CCT nominal: 4000K

Lifetime (L80/B10): >50000h tq +25°C

ILLUMINOTECHNICAL CHARACTERISTICS

Wall Washer optical system: a high reflectance anodised aluminium reflector, holographic diffuser filter, frame in black polycarbonate.

Optic: WALL WASHER

Optical efficiency: 64%

Fixture flux: 453lm

Luminous efficacy: 55lm/W

Photobiological safety: Compliant with RG1 low risk group

MECHANICAL CHARACTERISTICS

Black painted die-cast aluminium body. Sizes 125x25mm.

Colour and finish: Deep black

Dimensions: 25x125mm

Weight: 0.24Kg

Version: DIGITAL DIMMING

Degree of protection: IP20

ELECTRICAL CHARACTERISTICS

Fixture Power: 8W

Power supply: 48Vdc

Insulation Class: CLASS 3

Class F: YES

Ambient temperature: 0°C / +25°C

INSTALLATION

Extremely rapid, versatile and simple mechanical and electrical coupling system using magnets which support the fixture on the Power Track and feed power inside the fixture on all versions.

NOTES

Digital Dimming version. 110-277Vac version available on request.

WARRANTY

5 years.

Due to the technological evolution of the electronic components, the data provided may be updated, and as such, confirmation must be requested during the order process.

Luminous flux and power supply have +/-10% tolerances with respect to the indicated value. tq +25°C (CIE 121).

We reserve the right to make technical changes.

Targetti Sankey S.r.l.
Via Pratese, 164
50145 Firenze - Italy
Tel: +39 055 37911
targetti.com
targetti@targetti.com

CCIAA Firenze
Share Capital:
€ 500.000,00
VAT N. (IT):
01537660480
R.E.A: FI-275656

TARGETTI